

# Dimensions

## Control and signalling units Ø 22

Harmony® style 4  
 Pushbuttons, switches and pilot lights, with chromium plated metal bezel  
 Complete units, XB4-B : contact functions

**Pushbuttons, spring return**  
**XB4-BA●●**

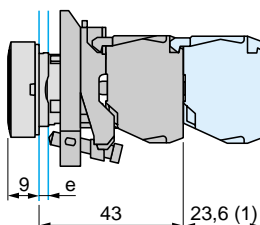

**XB4-BL●●**

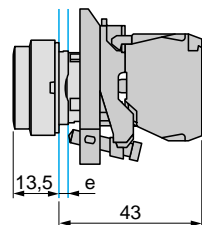

**Common face view**

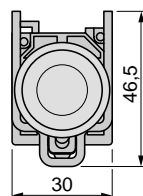

**XB4-BP●●**

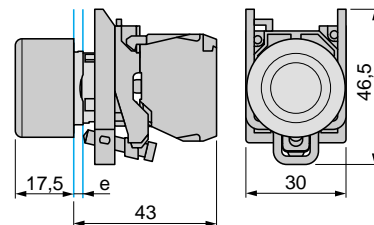

**Mushroom head pushbuttons, spring return**  
**XB4-BC21**

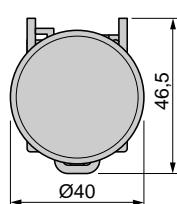
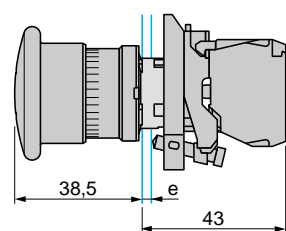

**Double-headed pushbuttons, spring return**  
**XB4-BL●45, BL●4C5**

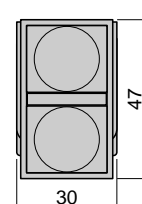
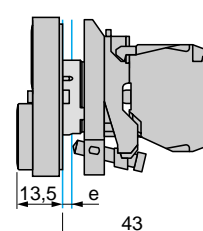

e : panel thickness 1 to 6 mm.  
 (1) Additional row of contacts or double contact.

**Emergency stop and mushroom head pushbuttons**  
**XB4-BT42, BT845**

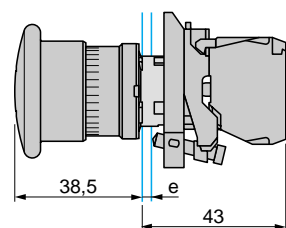

**XB4-BS542, BS8441, BS8444, BS8445**

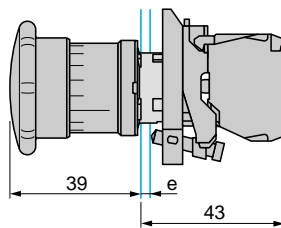

**XB4-BS142, BS9445**

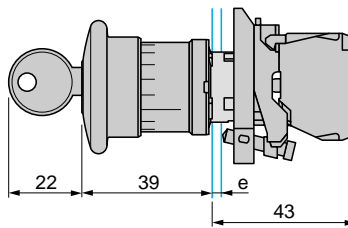

**Common face view**

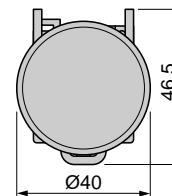

e : panel thickness 1 to 6 mm.

**Selector switches**  
**Standard handle operator**  
**XB4-BD**

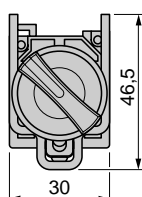
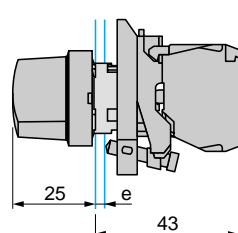

**Long handle operator**  
**XB4-BJ**

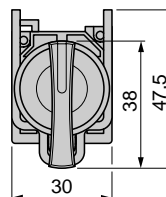
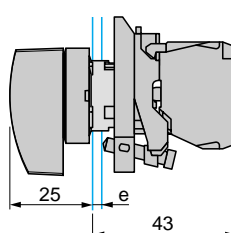

**Key switches**  
**XB4-BG**

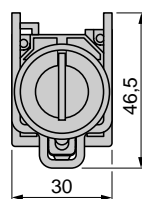
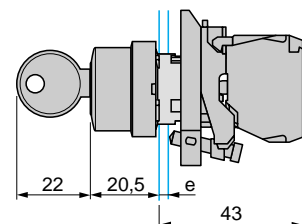

**Heads for toggle switches**  
**ZB4-BD●8**

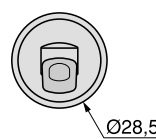
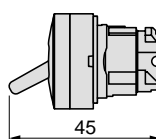

e : panel thickness 1 to 6 mm.

General : [pages 36022/2 to 36024/5](#)    Characteristics : [pages 36001/2 to 36001/5](#)    References : [pages 36002/2 to 36009/3](#)

# Control and signalling units Ø 22

Harmony® style 4

Pushbuttons, switches and pilot lights, with chromium plated metal bezel

Complete units, XB4-B : light functions with and without contacts

**Pilot lights**  
Integral LED  
XB4-BVB●, BVG●, BVM●

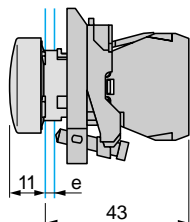

**Direct supply**  
XB4-BV6

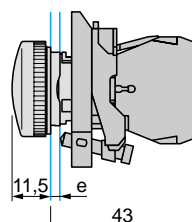

**Via integral transformer**  
XB4-BV3●, BV4●

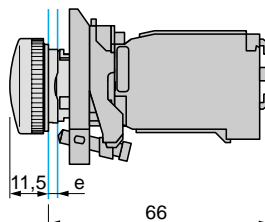

Common face view

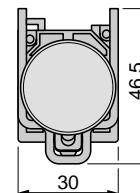

e : panel thickness 1 to 6 mm.

**Illuminated pushbuttons**  
Integral LED  
XB4-BW3●●5

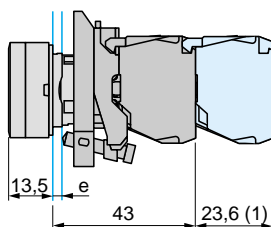

**Direct supply**  
XB4-BW3●65

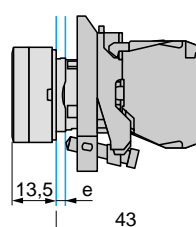

**Via integral transformer**  
XB4-BW3●●5

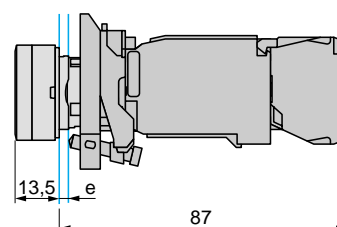

Common face view

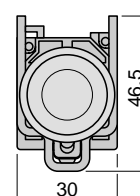

**Double-headed pushbuttons with pilot light**  
Integral LED  
XB4-BW84●5

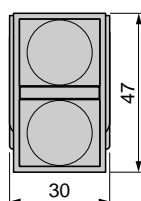
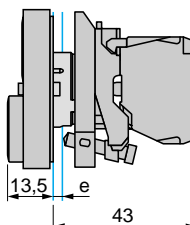

**Illuminated selector switches**  
Integral LED  
XB4-BK12●●5

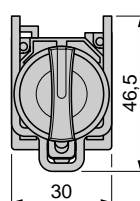
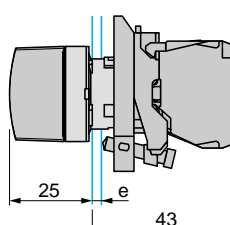

e : panel thickness 1 to 6 mm.

(1) Additional row of contacts or double contact.

**Support panel cut-out for pushbuttons, switches and pilot lights (1)**

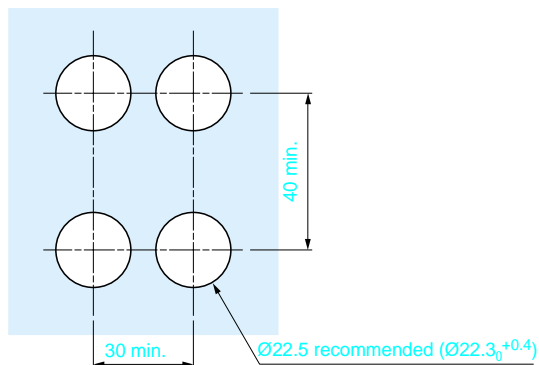

(1) Fixing centres for pushbuttons, switches and pilot lights fitted with Faston connector terminals : 32 x 45 min.

# Control and signalling units Ø 22

Harmony® style 4

Pushbuttons, switches and pilot lights, with chromium plated metal bezel

Sub-assemblies, ZB4-B : contact functions

Heads for pushbuttons, spring return  
ZB4-BA●, BA●●●, ZB4-BA●8  
ZB4-BL●, BL●●●

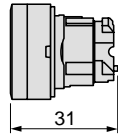
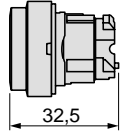
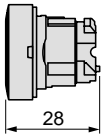

Common face view

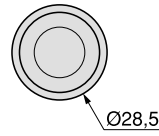

ZB4-BP●●  
ZB4-BP●S

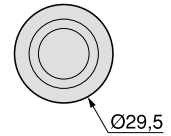
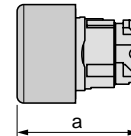

ZB4-	a
BP●●	36,5
BP●S	33

Heads for double-headed pushbuttons, spring return  
ZB4-BA81●●, ZB4-BA82●●  
ZB4-BL83●●, ZB4-BL84●●

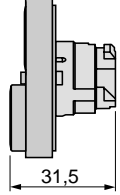
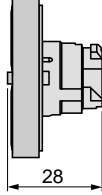

Common face view

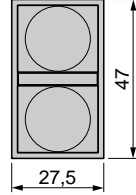

ZB4-BA91●●, ZB4-BA92●●

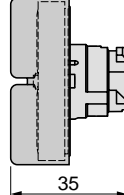

ZB4-BL93●●, ZB4-BL94●●

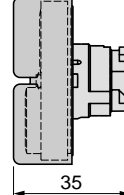

Vue de face commune

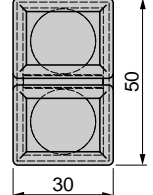

Heads for pushbuttons  
"Push-push to release"  
ZB4-BH0●, ZB4-BH●

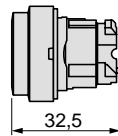
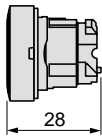

Common face view

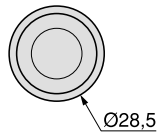

Mushroom head  
ZB4-BC●4

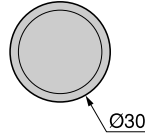
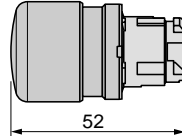

ZB4-BC●, BR●

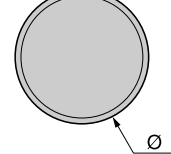
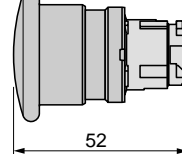

ZB4-	Ø
BC●	40
BR●	60

Mushroom heads for pushbuttons, latching  
Push-pull  
ZB4-BT●, BT●4

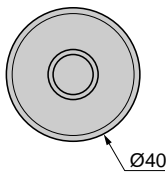
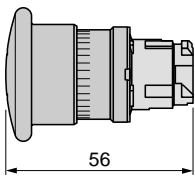

ZB4-BX2, BX4

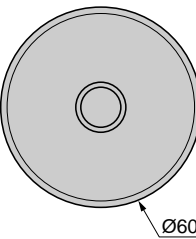
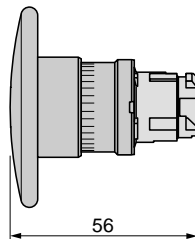

ZB4-BR●16

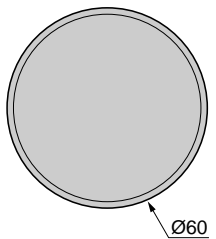
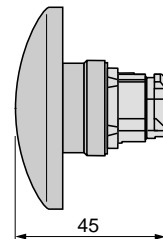

Turn to release  
ZB4-BS4●, BS834

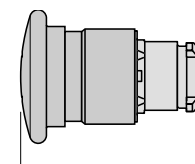

ZB4-BS5●, BS844, BS6●

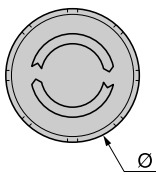
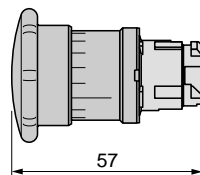

ZB4-	Ø
BS5●, BS844	40
BS6●	60

# Control and signalling units Ø 22

Harmony® style 4

Pushbuttons, switches and pilot lights, with chromium plated metal bezel

Sub-assemblies, ZB4-B : contact functions

**Mushroom heads for pushbuttons, latching (continued)**

**Key release**

**ZB4-BS7, BS934**

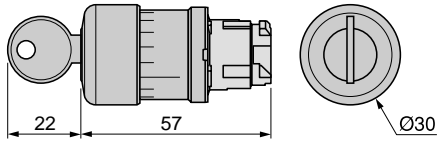

**ZB4-BS1, BS2, BS944, BS964**

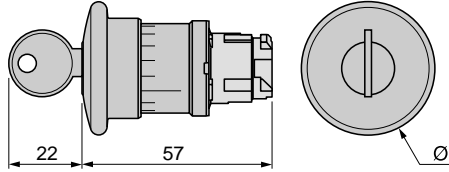

<b>ZB4-</b>	<b>Ø</b>
<b>BS1, BS944</b>	40
<b>BS2, BS964</b>	60

**Heads for selector switches**

**Standard handle**  
**ZB4-BD, BD0M**

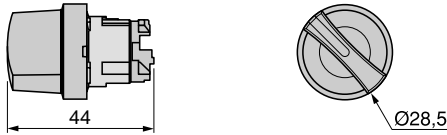

**Long handle**  
**ZB4-BJ, BD0M**

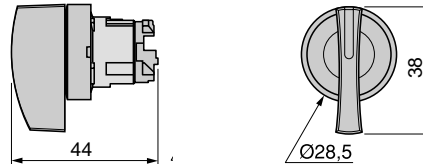

**Knurled knob**

**ZB4-BD9**



**Key switches**

**ZB4-BG, BG0, BG0M**

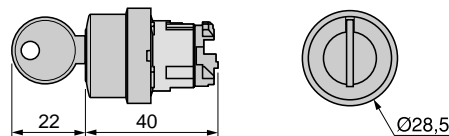

**Bodies for pushbuttons and switches**

**Screw clamp terminal connections**

**ZB4-BZ10, BZ141**

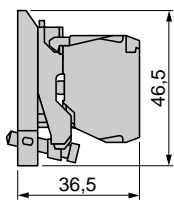

**Plug-in connector**

**ZB4-BZ10, BZ141**

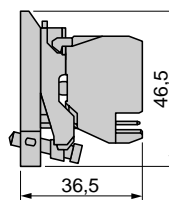

# Control and signalling units Ø 22

Harmony® style 4  
 Pushbuttons, switches and pilot lights, with chromium plated metal bezel  
 Sub-assemblies, ZB4-B : light functions with and without contacts

**Heads for pilot lights, with light source**

**Integral LED**  
 ZB4-BV0●3, BV0●3S

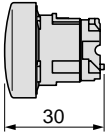

**Incandescent, neon or LED**  
 ZB4-BV0●, BV0●S

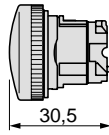

**Common face view**

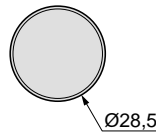

**Bodies for pilot lights, screw clamp terminal connections**

**Integral LED**  
 ZB4-BV●●

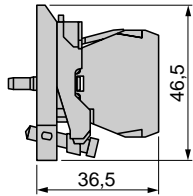

**Direct supply, for BA 9s bulb**  
 ZB4-BV6

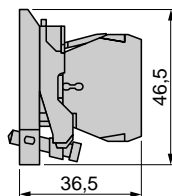

**Via integral transformer, for BA 9s bulb**  
 ZB4-BV●, BV●D●

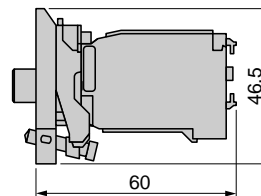

**Bodies for pilot lights, plug-in connector**

**Integral LED**  
 ZB4-BV●●4

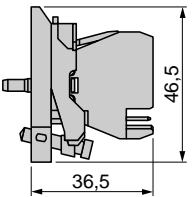

# Control and signalling units Ø 22

Harmony® style 4

Pushbuttons, switches and pilot lights, with chromium plated metal bezel

Sub-assemblies, ZB4-B : light functions with and without contacts

**Heads for illuminated pushbuttons, spring return, for LED light sources**

ZB4-BW3●3, BW3●3S  
ZB4-BW5●3, BA●8

ZB4-BW1●3  
ZB4-BL●8

Common  
face view

ZB4-BW9●3

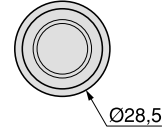
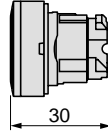
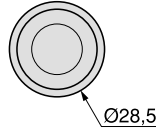
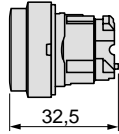
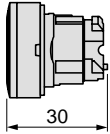

**Incandescent or neon**

ZB4-BW3●, BW3●S

ZB4-BW1●

Common  
face view

**Heads for Ø 40 mushroom head illuminated pushbuttons with integral LED**

ZB4-BW4●3, BW6●3

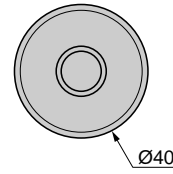
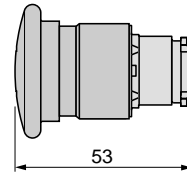
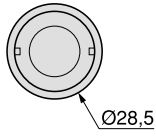
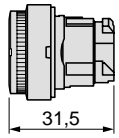
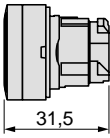

**Heads for double-headed pushbuttons with pilot light**

ZB4-BW81●●3,  
ZB4-BW82●●3

ZB4-BW83●●3,  
ZB4-BW84●●3

Common face view

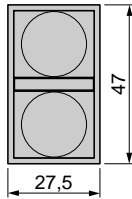
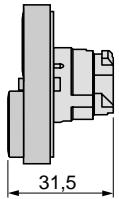
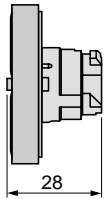

**Heads for "push-push to release" illuminated pushbuttons**

ZB4-BH0●3

ZB4-BH●3

Common face view

**Heads for illuminated selector switches, standard handle**

ZB4-BK1●●3

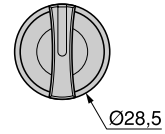
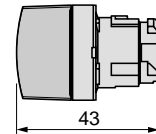
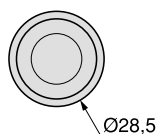
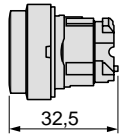
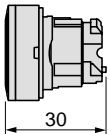

**Bodies for illuminated pushbuttons and selector switches**

**Screw clamp terminal connections**

Integral LED  
ZB4-BW0●●●

Direct supply,  
for BA 9s bulb  
ZB4-BW0●●

Via integral transformer,  
for BA 9s bulb  
ZB4-BW0●●, BW0●D●●

Plug-in connector  
Integral LED  
ZB4-BW0●●●4

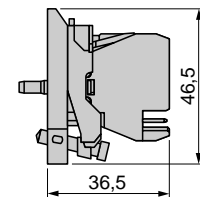
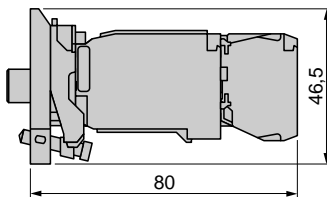
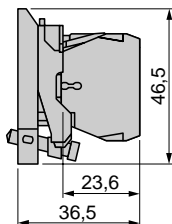
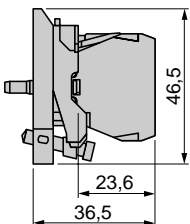

# Control and signalling units Ø 22

Harmony® style 4  
 Pushbuttons, switches and pilot lights, with chromium plated metal bezel  
 Specific functions

**Manual overload reset buttons  
 XB4-BA9●●**

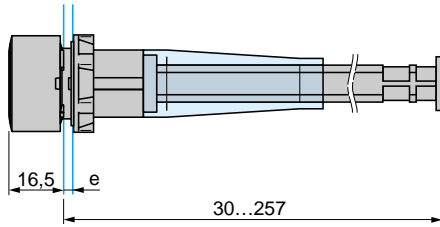

Common face view

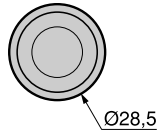

**Head + mounting base for potentiometer  
 ZB4-BD9●2**

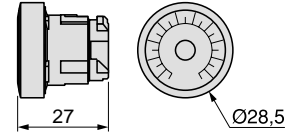

**XB4-BA8●●**

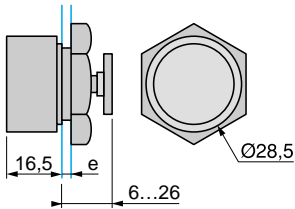

e : panel thickness 1 to 6 mm.

**Joystick controllers  
 XD4-PA●2**

**XD4-PA●4**

Common face view

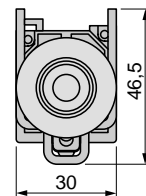
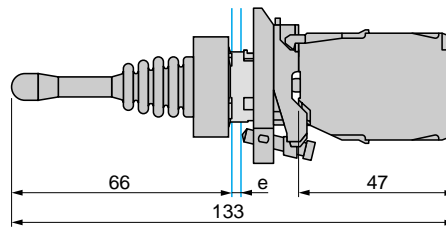
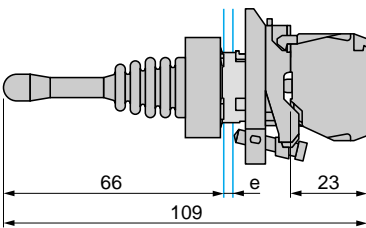

e : panel thickness 1 to 6 mm.

**Hour counters  
 XB5-DS●**

**Annunciators  
 XB5-KS●**

**Connection diagram  
 XB5-KS●**

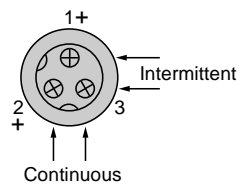
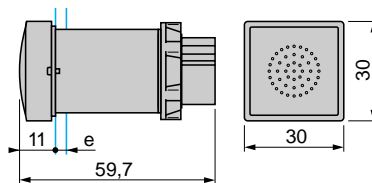
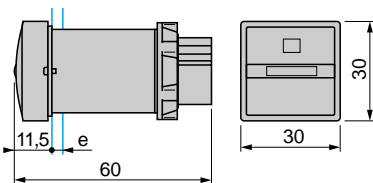

e : panel thickness 1 to 6 mm.

General :  
[pages 36022/2 to 36024/5](#)

Characteristics :  
[pages 36001/2 to 36001/5](#)

References :  
[pages 36002/2 to 36009/3](#)

# Control and signalling units Ø 22

Harmony® style 4

Pushbuttons, switches and pilot lights, with chromium plated metal bezel

Sub-assemblies, ZB4-B

## Connecting control units to printed circuit board

Panel cut-out (viewed from installer's side)

Dimensions in mm

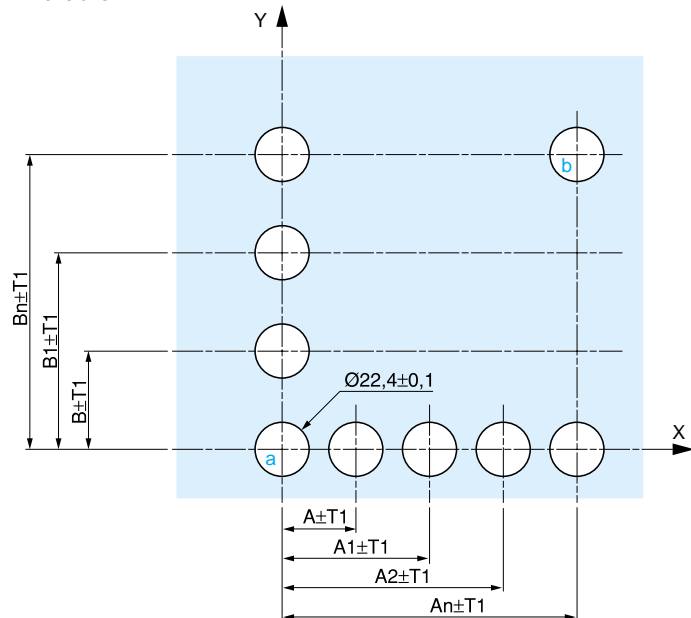

## Printed circuit board drillings (viewed from electrical block side)

Dimensions in mm

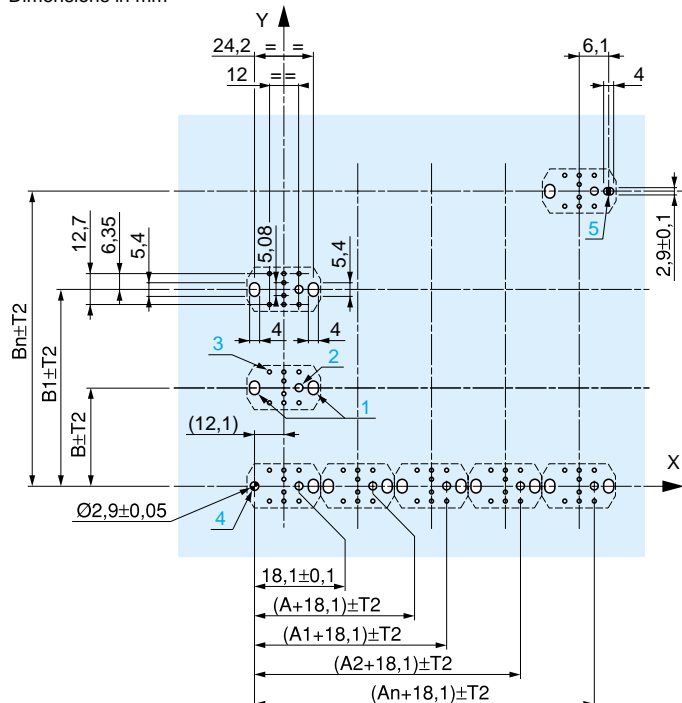

A : 30 min.

B : 40 min.

## General tolerances of the panel and printed circuit board

The cumulative tolerance must not exceed 0.3 mm :  $T1 + T2 = 0.3$  mm maximum.

## Installation precautions :

Minimum thickness of circuit board : 1.6 mm

Cut-out diameter : 22.5 mm recommended ( $22.3^{+0.4}$ )

Orientation of body/fixing collar ZB4-BZ009 :  $\pm 2^\circ 30'$  (excluding cut-outs marked a and b).

Fixing screw ZBZ-006 tightening torque : 0.6 N.m

Allow for pillar ZB4-BZ079 and fixing screws every 90 mm horizontally (X), and 120 mm vertically (Y) (for cut-outs on 30 x 40 mm fixing centres).

The fixing centres marked a and b are diagonally opposed and must align with those on the printed circuit board marked 4 and 5.

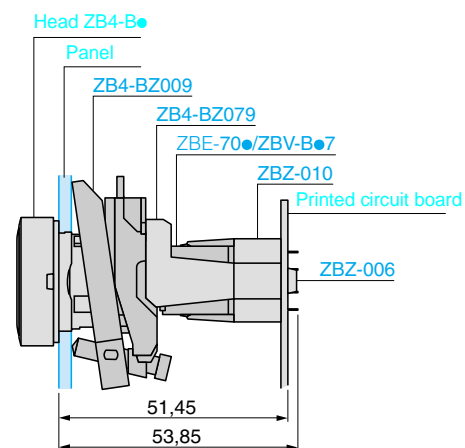

## Mounting with adaptor (socket) ZBZ-010 :

- 1 2 elongated holes for ZBZ-006 screw access
- 2 1 hole  $\text{Ø} 2.4$  mm ( $\pm 0.05$ ) for centering adaptor ZBZ-010
- 3 8 holes  $\text{Ø} 1.2$  mm
- 4 1 hole  $\text{Ø} 2.9$  mm ( $\pm 0.05$ ) for centering printed circuit board (with cut-out marked a)
- 5 1 elongated hole for orientating the printed circuit board (with cut-out marked b)

Dimensions  $A_n + 18.1$  are those to the  $\text{Ø} 2.4$  mm ( $\pm 0.05$ ) holes for centering the adaptor ZBZ-010.