

Control and signalling units Ø 22

Harmony® style 4
 Pushbuttons, switches and pilot lights, with chromium plated metal bezel

Description

The Ø 22, style 4 range of control and signalling units comprises :

Complete units XB4-B



Pushbuttons and switches

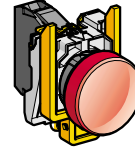

Pilot lights

Sub-assemblies for user assembly ZB4-B

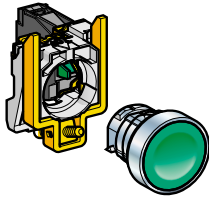

Pushbuttons and switches :
Head and body
sub-assemblies

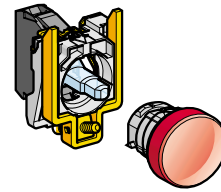

Pilot lights :
Head and body
sub-assemblies

Component parts and accessories ZB

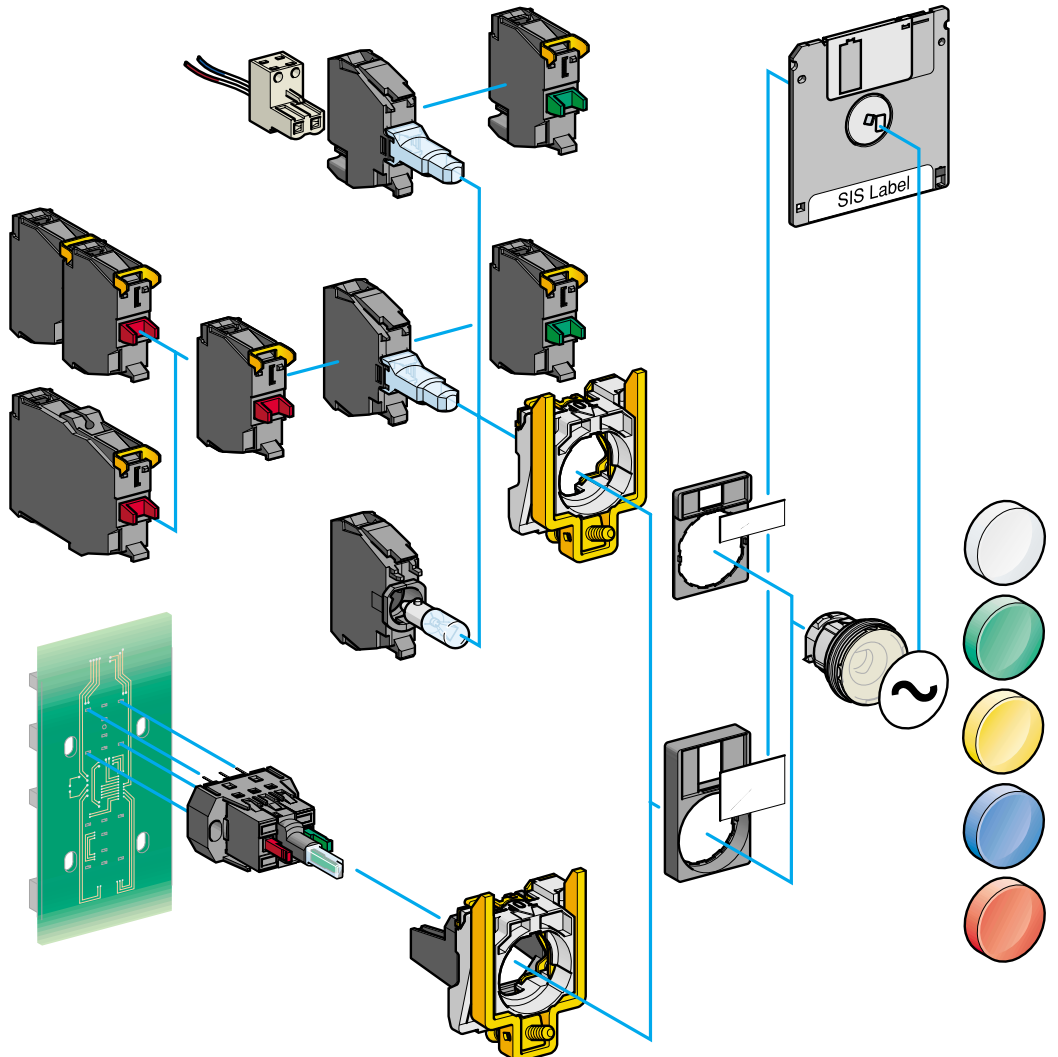

Harmony® style 4

Pushbuttons, switches and pilot lights, with chromium plated metal bezel

Pushbuttons and Emergency stop pushbuttons



Pushbutton
N/O contact



Pushbutton
N/C contact



Mushroom head,
spring return
N/O contact



Emergency stop latching
mushroom head. Push-pull
N/C contact

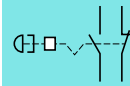

Emergency stop trigger
action mushroom head
Push-pull
N/O + N/C contact



Emergency stop trigger
action mushroom head
Turn to release - N/C contact



Emergency stop trigger
action mushroom head
Key release - N/C contact



Emergency stop trigger
action mushroom head
Turn to release
N/O + N/C contact



Emergency stop trigger
action mushroom head
Key release
N/O + N/C contact



Double-headed pushbutton
N/O + N/C contact

Selector switches



Selector switch - 2 position,
stay put
N/O contact

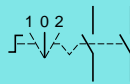

Selector switch - 3 position,
stay put
N/O + N/O contact

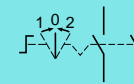

Selector switch - 3 position,
2 spring return to centre
N/O + N/O contact



Selector switch - 2 position,
stay put, key withdrawal LH
position - N/O contact

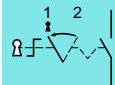

Selector switch - 2 position,
spring return from right to left,
key withdrawal LH position
N/O contact

Pilot lights



Pilot light with BA 9s
incandescent bulb



LED pilot light



Pilot light with integral transformer, 230 V c primary,
6 V secondary. BA 9s incandescent bulb or LED

Illuminated pushbuttons and selector switches

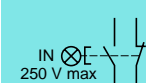

Illuminated pushbutton
BA 9s incandescent bulb
N/O + N/C contact



Illuminated pushbutton
with LED
N/O + N/C contact

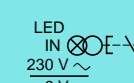

Illuminated pushbutton
with integral transformer,
230 V c 50/60 Hz primary,
6 V secondary.
BA 9s incandescent bulb or LED
N/O + N/C contact

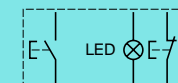

Double-headed pushbutton
with LED pilot light
N/O + N/C contact

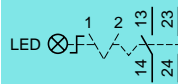

Illuminated selector switch
With Led-2 position stay put
N/O + N/C contact

Joystic controllers

2 direction



Without
spring return

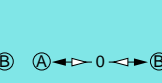

With
spring return

4 direction



Without
spring return

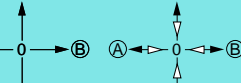

With spring
return

Control and signalling units Ø 22

Harmony® style 4
 Pushbuttons, switches and pilot lights, with chromium plated metal bezel
 Complete units, XB4-B

Complete units ready for mounting

Pushbuttons, spring return

Contact functions



Flush push

XB4-BAp1/BA42
 see page 36002/2

XB4-BA3311
 see page 36002/2

XB4-BA4322
 see page 36002/2

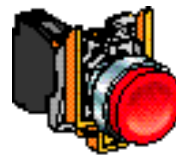
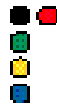

Booted flush push

XB4-BPp1/BP42
 see page 36002/2

Projecting push

XB4-BL42
 see page 36002/2

Mushroom head

XB4-BC21
 see page 36002/2

Double headed pushbuttons, spring return



Flush push + projecting push

XB4-BL845
 see page 36002/2

Booted flush push + projecting push

XB4-BL945
 see page 36002/2

Ø 40 Emergency stop and mushroom head pushbuttons without/with trigger action

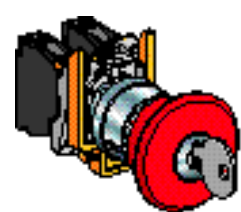
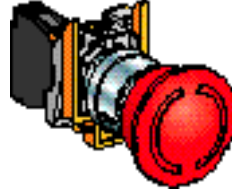
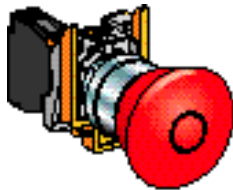

Push-pull

XB4-BT42/BT845
 see page 36002/3

Turn to release

XB4-BS542/BS8445
 see page 36002/3

Key release

XB4-BS142/BS9445
 see page 36002/3

Selector switches and key switches



Standard black handle
 XB4-BD
 see page 36002/3

Long black handle
 XB4-BJ
 see page 36002/3

Key switches
 XB4-BG
 see page 36002/3

Control and signalling units Ø 22

Harmony® style 4
 Pushbuttons, switches and pilot lights, with chromium plated metal bezel
 Complete units, XB4-B

Complete units ready for mounting

Pilot lights

Signalling functions

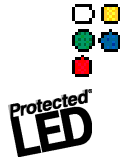

With integral LED

[XB4-BVB/BVG/BVM](#)
 see page 36003/2

For BA 9s bulb
 Direct supply

[XB4-BV6](#)
 see page 36003/3

Via integral transformer

[XB4-BV3/BV4](#)
 see page 36003/3

Combined contact and signalling functions

Illuminated pushbuttons, spring return, flush push

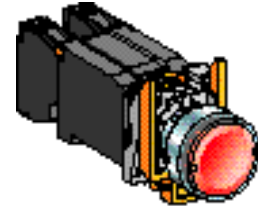
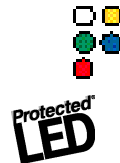

With integral LED

[XB4-BW3pB5/BW3pG5/BW3pM5](#)
 see page 36004/2

For BA 9s bulb
 Direct supply

[XB4-BW3p65](#)
 see page 36004/2

Via integral transformer

[XB4-BW3p35/BW3p45](#)
 see page 36004/3

Double-headed pushbuttons, spring return, with pilot light



With integral LED

[XB4-BW84p5](#)
 see page 36004/3

Illuminated selector switches, standard handle



With integral LED

[XB4-BK12pB5/BK12pG5/BK12pM5](#)
 see page 36004/3